



**SNOWLAND**  
COOLING SYSTEMS L.L.C.

# Experience The Excellence

A comprehensive bouquet of  
commercial & Industrial refrigeration

# COMPANY PROFILE

Snowland is a manufacturer and exporter of commercial and industrial refrigeration equipment utilizing HCFCs/HFCs refrigerants and ammonia refrigerant. Since our inception in 1998, we have successfully met the needs of our customers. Starting humbly, we have aimed to fulfill the requirements of refrigeration equipment, from production to after-sales service.

Our vision to become a globally recognized leader in refrigeration equipment, in terms of quality, price, and service, has always been clear. Our three-tier policy emphasizes customer satisfaction through a comprehensive product range and an extensive service network. To achieve this, we have recruited efficient, qualified, and dedicated human resources. Snowland Refrigeration's primary objective is customer satisfaction, not profit.

We focus on excellence, the highest quality, and technological leadership. We continuously redefine quality to provide world-class products and services, setting higher and higher standards of customer-oriented quality. The word-of-mouth publicity from our satisfied customers has helped us acquire new references and capture a significant market share in the industry.

## From the Desk of CMD

We're still on course to achieve our objective of becoming a reputable leader in refrigeration equipment, distinguished by our superior quality, affordability, and aftercare. There are obstacles in the way of realising our goal, but if we continue to be inventive, creative, and efficient, we can succeed. We have to keep up the high calibre of work, moral character, and first-rate customer support that our customers have grown to expect from us.

We started off modestly thirty years ago when we began producing refrigeration equipment. We are pleased to see that Snowland has developed into one of the market leaders, a dependable and recognised producer, and a supplier of cooling solutions to a wide range of clients worldwide.



### **Objective**

Our objective is customer satisfaction over profit margin. The word-of-mouth publicity of our satisfied customers has helped us not only to acquire new references but also to capture a significant market share in the industry.



### **Mission**

Dedicately produce high quality end-to-end customized cooling solutions for divers set of customers across the industries and consistently exceed customers' expectations through quality on-time delivery and after sales services



### **Vision**

Create Snowland as an Industry leader in offering total cold chain and food processing solution with energy saving & eco-friendly products and excellent after sales service.



### **Commitment**

We are committed to quality, integrity and excellence in all areas of business. We pledge to monitor our performance as an on-going activity and strive for continual improvement, through enhancing skills of all employees through training and motivation.



### **Quality**

Top Rated components and best in class materials are the foundation of every equipment we build. Our highly qualified and experienced staff of engineers, designers and technicians ensure you receive the highest quality products every time.



### **Efficiency**

Our dedicated refrigeration facility of manufactures of products situated at UAE & India and distributes refrigerated products around the globe resulting in faster, simpler and more efficient business operations.



### **Innovation**

We are listening! At Plant, our customers drive innovation at every turn. Visit our plant, R&D lab and see how we can assist you to achieve customized display objective.



### **Trust**

Our reputation for independence and integrity enables us to build trust wherever needed. We achieved sustainable business growth by value creation through hard work and maintaining trust and respect of the clients and stakeholders.

# Snowland - At a Glance



## Our Business Vertical

### Transport refrigeration



### Insulated Panels & Doors Factory



## Core Values

**Innovation:** We drive progress by integrating the latest technologies, such as IoT and BMS, into our temperature control systems, enabling smarter, more efficient operations.

**Quality:** Every product and solution we offer is built to the highest standards of reliability, durability, and performance.

**Sustainability:** We prioritize eco-friendly practices in our manufacturing processes and products, helping our clients reduce their environmental impact.

**Customer Focus:** Our clients are at the center of our operations. We work closely with them to understand their needs and provide customized solutions that exceed expectations.

**Integrity:** We operate with transparency, honesty, and a strong commitment to ethical business practices.

## Refrigeration Units



## Contracting



# Transport Refrigeration

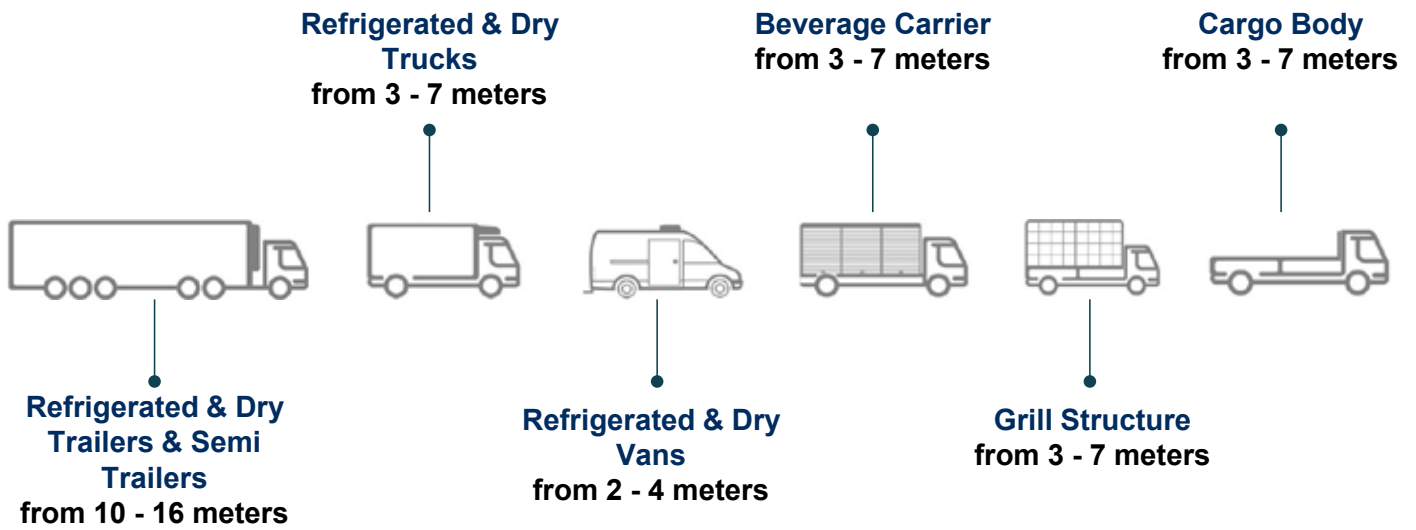

Snowland Cooling Systems LLC is a premier manufacturer specializing in transport refrigeration systems. With a strong commitment to quality, innovation, and customer satisfaction, we provide state-of-the-art refrigeration solutions that ensure the safe and efficient transportation of perishable goods. Our systems are designed to meet the stringent requirements of the logistics and transportation industry, offering reliability, energy efficiency, and precise temperature control.





Movable Partition



Meat Hanging Rails



Cargo Restraints



Folding Steps



Racking Solutions



Tail Lift



Air Deflector



Vehicle Branding

# Insulated Panels and Doors Factory



Manual/Automatic Sliding Doors



Self closing flush type hinge door



Meat Rail Door



Sectional overhead door



High speed roll-up door



Swing door



Hatch door



Overlap hinge door



Insulated Glass door



Corner Panel with PVC Coving



Partition Panel



Corner Coving Wall to Ceiling



PVC Coving with Alu. Backing

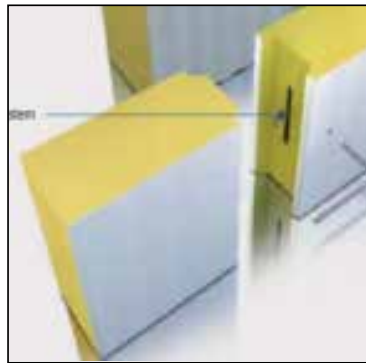

Wall to Wall Cam Locking Arrangement



Corner Coving Floor to wall



Wall to Ceiling Cam Locking

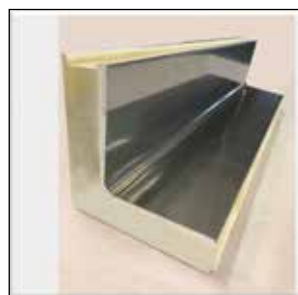

Rounded Corners



Gaskets



Floor to Wall Cam Lock



# Floors

Cold room flooring systems are engineered to handle heavy loads, constant movement, and strict hygiene standards. Built with durable steel surfaces, and high-density polyurethane insulation, these floors deliver excellent strength and thermal efficiency. As a result, Snowland solutions ensure reliable performance for cold rooms and cold storage facilities.

## Standard roll-in floor

**Top Surface:** 12mm thick Marine-grade plywood for moisture resistance and durability.

**Bottom Surface:** Pre-painted galvanized sheet for structural integrity and moisture protection  
**Core,** High-density polyurethane insulation with reinforced structure to support heavy loads.

**Wearing Surface:** 3 mm thick Polyurea coating wearing surface for enhanced durability, slip resistance, and load-bearing capacity.

Insulation with injected polyurethane  $D=43 \text{ kg/m}^3$

Static load \* =  $6000 \text{ kg/m}^2$

Dynamic load \*\* = 1000 kg

Precise load \*\*\* = 320 kg

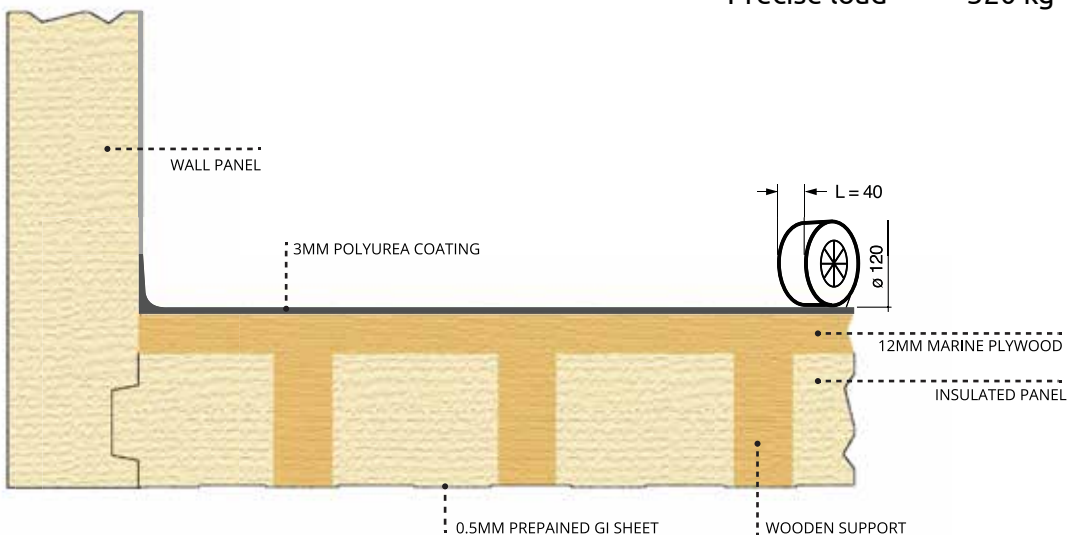

- \* **Static load:** For floors having underfloor spacers with 400 mm distance the load is reduced of 60%. Spacers with 200 mm distance the reduction is of 40%. The static load of walk-in floors remains unchanged.
- \*\* **Dynamic load:** On a non metallic 4 wheel trolley 120x40 ( see drawing )
- \*\*\* **Precise load:** On a limited surface of 10 cm<sup>2</sup> ( for example the foot of shelving )
- \*\*\*\* **Installation terms:** uniform bearing on concrete floor perfectly leveled

## Standard roll-in floor

**Top Surface:** 12mm thick Marine-grade plywood for moisture resistance and durability.

**Bottom Surface:** Pre-painted galvanized sheet for structural integrity and moisture protection Core, High-density polyurethane insulation with reinforced structure to support heavy loads.

**Wearing Surface:** 2 mm thick Aluminium chequered plate finish surface for enhanced durability, slip resistance, and load-bearing capacity.

Insulation with injected polyurethane  $D=43 \text{ kg/m}^3$

Static load \* =  $6000 \text{ kg/m}^2$

Dynamic load \*\* = 1000 kg

Precise load \*\*\* = 340 kg

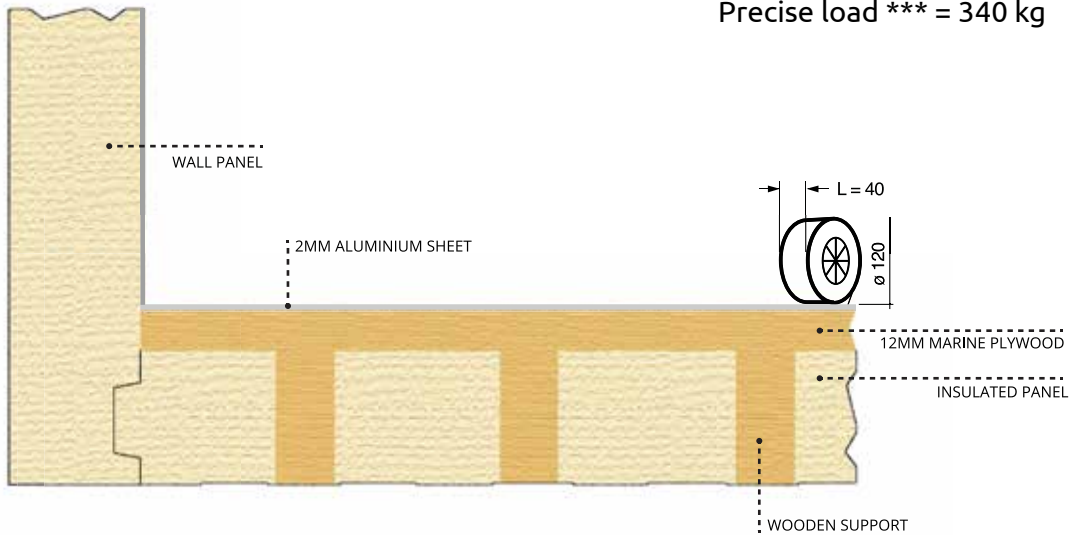

## Standard roll-in floor

**Top Surface:** 12mm thick Marine-grade plywood for moisture resistance and durability.

**Bottom Surface:** Pre-painted galvanized sheet for structural integrity and moisture protection Core, High-density polyurethane insulation with reinforced structure to support heavy loads.

**Wearing Surface:** 1.5 mm thick Stainless steel finish surface for enhanced durability, slip resistance, and load-bearing capacity.

Insulation with injected polyurethane  $D=43 \text{ kg/m}^3$

Static load \* =  $6000 \text{ kg/m}^2$

Dynamic load \*\* = 1000 kg

Precise load \*\*\* = 350 kg

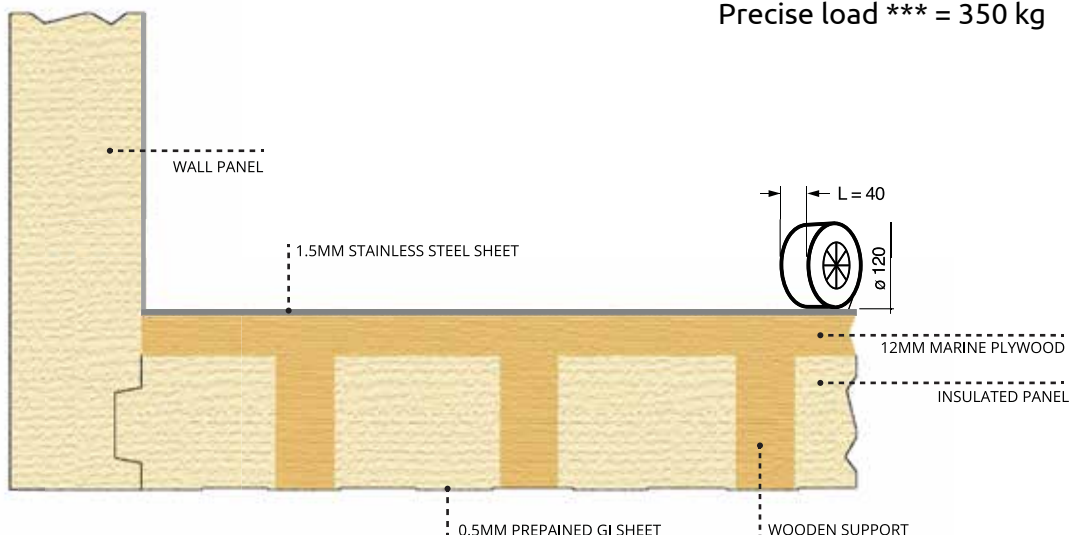

# Refrigeration Units

## Hermetic/scroll condensing units



Closed



Open



Scroll



Water Cooled



## Semi-hermetic condensing units



Air Cooled



Water Cooled



Capacity Control



Top Mounted



Condensing unit for warehouse



Double Stage

# Monoblock Refrigeration Unit



Light commercial unit



Commercial & Mobile



Light Commercial



Outdoor Unit



Air Duct Unit



# Compressor Racks (Power Pack)



Rack



Combo Rack



Screw Rack



Scroll Compressor Rack



Scroll Rack



Air Cooled



## Commercial Coolers / Evaporators



Slim



Cubic



Angular



Dual Discharge/Industrial  
Coolers

## Industrial Coolers / Evaporators



Ceiling Mounted/Floor Standing



Floor Standing



Floor Standing



Ceiling Mounted

## Remote Condensers



## Refrigeration Control Panels



## Commercial Flake Ice Machine



## Industrial Flake Ice Machine



## Marine Flake Ice Machine



## Slurry Ice Machine



## Tube Ice Machine



# Cold Room

Snowland is a leading manufacturer and supplier of highly efficient Cold Room and Storage that is easy to operate and better in performance. This tailor-made product range is built with premium quality range of material in standard size and customized specification to fulfil the customer needs. These Cold Rooms are well insulated, highly efficient and precise designed to cater to a wide temperature range from +15 °C to -40 °C and PUF Panel thickness 60, 80, 100, 125, 150 mm.



## Features

- ◆ Fully Customized & Portable
- ◆ High ambient refrigeration design
- ◆ Most durable
- ◆ Homogeneous PUF density
- ◆ All Side PVC Gasket
- ◆ Wall to Top Cam-Lock
- ◆ Different material of construction
- ◆ Easy to assemble and dismantle

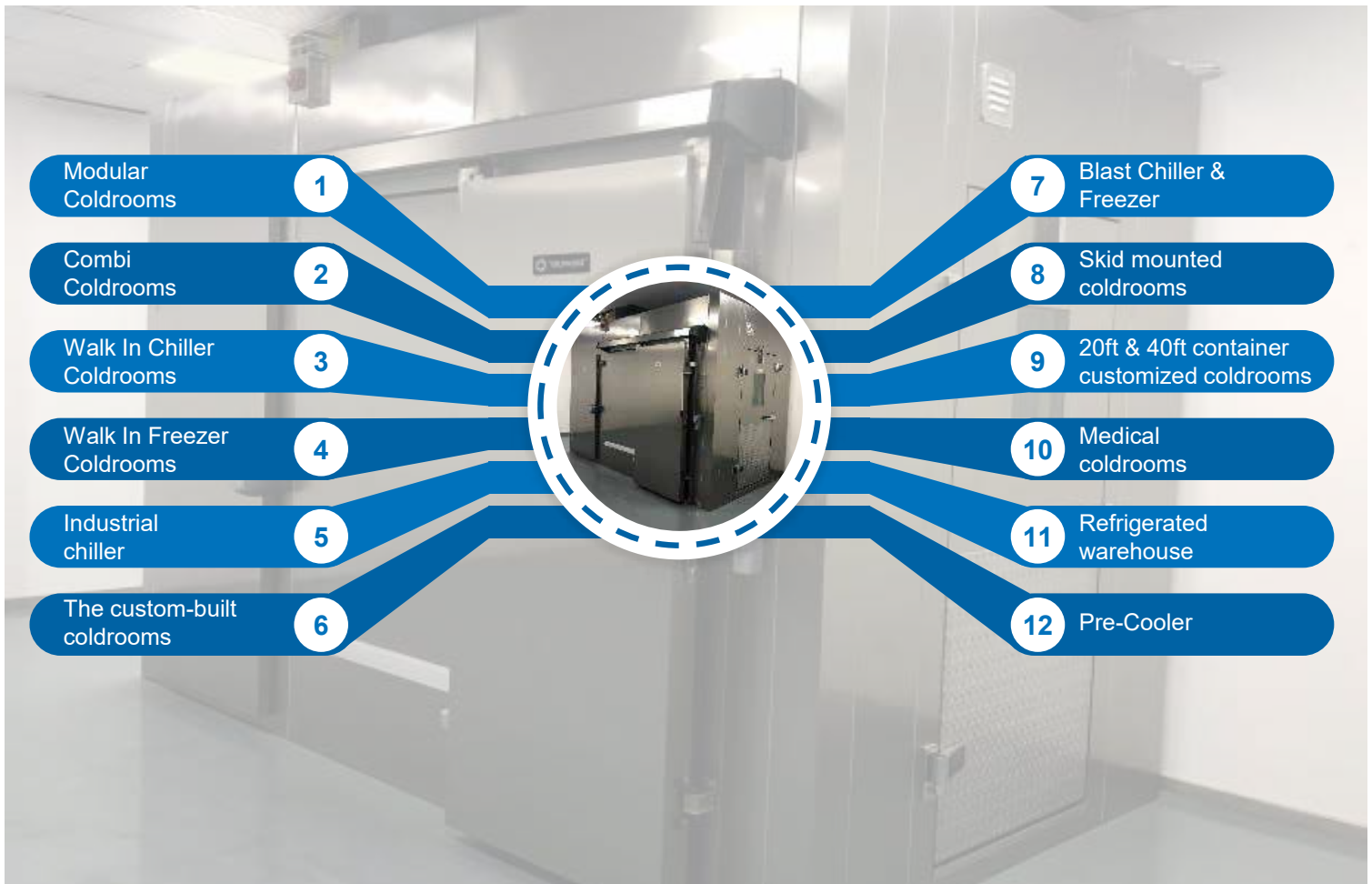

# Glass Door Coolers & Freezers

Snowland Cooling Systems LLC offers state-of-the-art walk-in glass door display chillers and freezers, perfect for showcasing products while maintaining optimal temperatures. Designed for supermarkets, retail stores, and foodservice establishments, our units combine sleek, modern design with superior functionality. The glass doors provide clear visibility, enhancing product presentation, while the robust cooling technology ensures consistent temperature control to keep products fresh and safe. With a focus on energy efficiency and durability, Snowland Cooling Systems LLC delivers display solutions that not only attract customers but also support sustainable business operations.

## Features



- ◆ Large Storage with Better Display Area
- ◆ Customized size
- ◆ Temperature retaining
- ◆ Easy maintenance
- ◆ Energy efficient
- ◆ Easy assemble & dismantle



# Solar Cold Room

Snowland's Solar Cold Room is a smart, energy-efficient refrigeration solution that combines solar and grid power for uninterrupted cooling performance. Designed to operate seamlessly even during cloudy days or at night, the hybrid system automatically switches between solar energy and electricity to maintain optimal temperature conditions. Ideal for agriculture, dairy, fisheries, and pharmaceuticals, Snowland's hybrid solar cold rooms ensure consistent freshness, lower operating costs, and reduced carbon emissions. Built with durable materials and intelligent controls, they deliver reliable, sustainable, and cost-effective cold storage — anytime, anywhere.



NO.	Accessories	Specifications	Qty	Picture
1	Solar Panel Trina	610w 25years output warranty	10	
2	Bracket	Complete Set 15 years warranty	1	
3	Brand:Growatt Solar Inverter SPE 12000 ES	Rated Power:12KW AC output Voltage: 220V 2 years warranty	1	
4	Solar Li Battery	51.2v 314ah 16.08kwh 5 years warranty	2	
6	Auxiliary materials	PV cables 4 m2	100	
7	Connector	Installation accessories	1 set	

## Key Features of Solar Cold Room

- ◆ Solar-Powered Operation – Runs efficiently on solar energy, reducing dependence on grid power and diesel generators.
- ◆ Hybrid Power System – Works seamlessly on both solar and conventional electricity to ensure uninterrupted cooling 24/7.
- ◆ Temperature Control Range – Adjustable temperature from +2°C to -20°C, suitable for fruits, vegetables, dairy, meat, and pharmaceuticals.
- ◆ Energy-Efficient Design – High-performance insulation panels and efficient compressors minimize power consumption.
- ◆ Smart Monitoring System – Integrated digital controller for temperature monitoring, data logging, and remote alerts.
- ◆ Long Battery Backup – Advanced battery storage ensures continuous operation during night or cloudy conditions.
- ◆ Modular Construction – Easy to install, expand, or relocate as per requirement.
- ◆ Rugged & Weather-Resistant – Built with durable materials to withstand extreme outdoor conditions.
- ◆ Environment-Friendly – Reduces carbon footprint and operational costs through renewable solar power.
- ◆ Low Maintenance – Designed for long life with minimal service requirements.

# Intelligent Mushroom Cultivation Solutions

## Smart Farming Redefined with Precision Technology

Snowland introduces advanced intelligent mushroom cultivation chambers designed to deliver consistent quality, higher yields, and operational efficiency. Built for modern agricultural needs, these solutions create a perfectly controlled environment that supports reliable and scalable mushroom production.

At the core of Snowland's system is a smart control mechanism that precisely regulates temperature, humidity, and CO<sub>2</sub> levels. This ensures ideal conditions for mycelium development and uniform mushroom growth. As a result, growers benefit from enhanced productivity, improved crop quality, and visually superior mushrooms with better nutritional value.



## Modular, Scalable, and Easy to Deploy

The containerized, plug-and-play design makes Snowland systems highly flexible and easy to install. Whether used in farms, urban setups, or research facilities, these units can be deployed quickly with minimal infrastructure. Constructed using high-grade, hygienic materials, they offer durability, corrosion resistance, and long-term reliability.

## Maximized Productivity with Intelligent Design

Snowland chambers are engineered with vertical cultivation systems that significantly increase space utilization. Optimized airflow and advanced humidification ensure a balanced internal climate, preventing direct airflow stress while maintaining consistent growing conditions across all levels.



## Energy-Efficient and Future-Ready Operations

With energy-saving technologies such as DC inverter systems and intelligent ventilation, Snowland solutions reduce operational costs while maintaining optimal performance. Remote monitoring and smart controls enable real-time adjustments, ensuring efficient and hassle-free operations

## Empowering Sustainable and Profitable Farming

Snowland's intelligent cultivation solutions are designed to support sustainable agriculture while maximizing returns. By combining automation, precision control, and efficient design, Snowland helps businesses achieve reliable production, reduced wastage, and long-term profitability in mushroom farming.



# Ammonia Refrigeration

Snowland Cooling Systems LLC is a leader in ammonia refrigeration manufacturing, offering robust and efficient solutions for industrial cooling needs. Our ammonia refrigeration systems are designed to provide powerful cooling while minimizing environmental impact, making them an ideal choice for industries such as food processing, cold storage, and beverage production. Known for their reliability and energy efficiency, our systems ensure consistent performance even in the most demanding conditions. With a commitment to innovation and sustainability, Snowland Cooling Systems LLC delivers top-tier ammonia refrigeration solutions that help our clients achieve operational excellence and reduce their carbon footprint



# Curd Incubation Chamber

We provides fully automatic combo type incubation chambers for curd with heating and cooling both process together in a single chamber. Curd / Yogurt known for its characteristic, sweet-tart taste and semi solid consistency. It is also religiously as well as scientifically proven good for health. But - We can't retain its taste and quality equal due to variations in Indian weather conditions and slight deviations in procedure. So, as a solutions, Snowland provides you exact methodology with appropriate temperature conditions on basis of our wide experience and some expert's advice.



## Features

- ◆ **Model:** Static Type & Portable Type
- ◆ **Incubation Capacity:** 360 to 4000 Ltr
- ◆ **Incubation Temperature:** +40 °C to +45 °C
- ◆ **Blast Chilling Capacity:** 150 to 1500 Ltr
- ◆ **Blast Chilling Temperature:** -5 °C to +8 °C (optional)
- ◆ **Application:** Curd Incubation



# Dehumidifier

Our portable dehumidifier provide low humidity conditions necessary to maintain a dry environment. It's a simple solution to an old problem. Our Dehumidifier works by forcing condensation on cold surfaces. Humid air is drawn over cooled fins that makes moisture condense on the large cool surface. The condensation is allowed to drain from the fins into a collection tank or is piped to a suitable drainage. Cooled dry air passes through condenser coil and again heated to desired temperature to maintain low relative humidity.

## Applications

- ◆ Sweet storage
- ◆ Seeds storage
- ◆ Dehydrated product storage
- ◆ Bakery product storage and many more

## Features

- ◆ Auto cut-off according to set RH value
- ◆ Automatic defrost
- ◆ Continuous Drainage Option Or water collecting tank
- ◆ Top air flow



# Blast Freezer / Chiller

At Snowland Cooling Systems LLC, we specialize in the design and manufacturing of high-performance blast chillers and freezers tailored for commercial and industrial applications. Our systems are engineered to rapidly lower the temperature of food products, ensuring optimal freshness, quality, and safety. Built with advanced technology and precision, our blast chillers and freezers deliver exceptional efficiency and reliability, making them the ideal choice for food processing plants, restaurants, and catering businesses. With a focus on energy efficiency and robust performance, Snowland Cooling Systems LLC provides solutions that meet the rigorous demands of the industry while supporting sustainable operations.



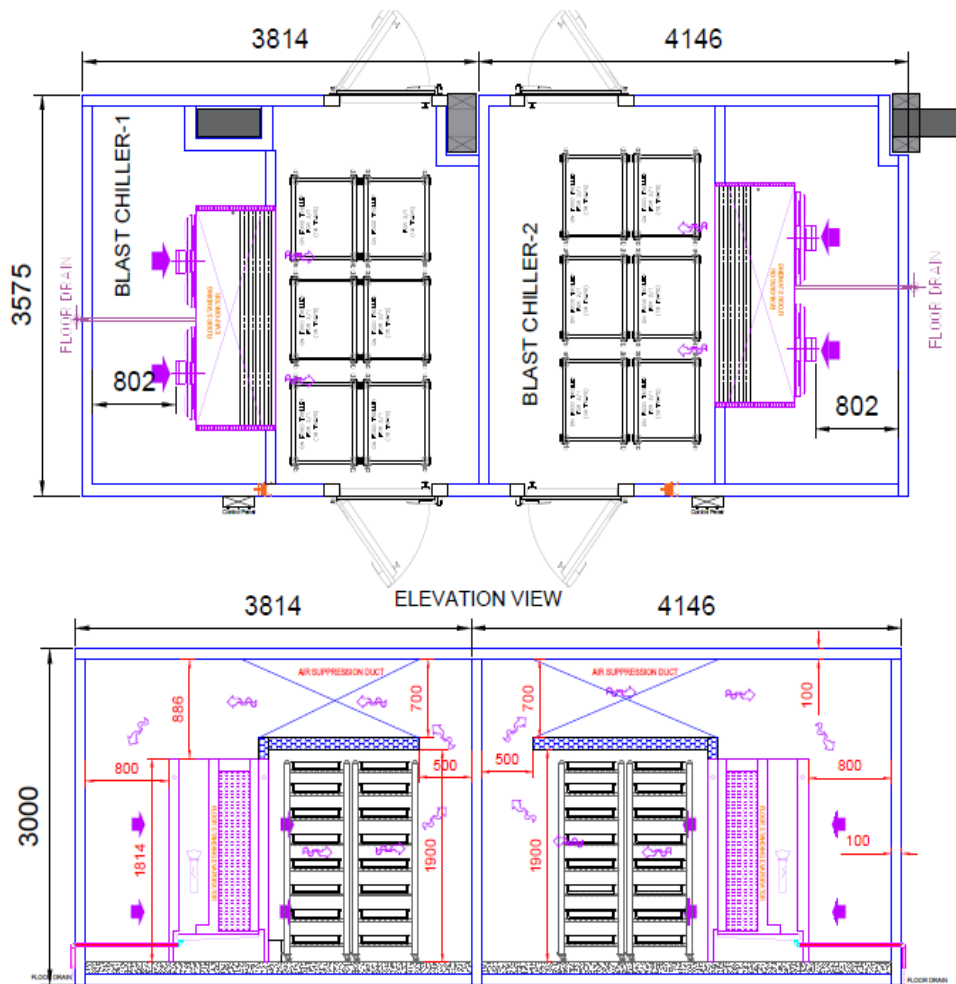

## Mini Blast Freezer / Chiller



Snowland Blast Freezer/Chiller are the essential system to extend the shelf-life of food by instant chilling/freezing. These machines are designed to meet customer's requirement to improve quality and organization of the work in hotel-restaurants, confectioneries, bakeries and ice-cream shops. These machines also help food meet the hygiene standards, preserving the quality of food, and reducing food wastage.

### **Pull down time/Temperature:**

- ◆ Chiller: 90 Minutes (From +70 °C to +10 °C)
- ◆ Freezer: 4 to 5 Hrs (From +10 °C to -18°C)

### **Features**

- ◆ Reduce the deterioration of products during the freezing process
- ◆ Increase the shelf life of the food product
- ◆ Maintain food quality including flavour, texture, colour, aroma and nutrients
- ◆ Save money by making use of seasonal and bulk offers
- ◆ Save labour by enabling larger batch production
- ◆ Reduce waste of less used products and preserve for later
- ◆ Add new products to menu
- ◆ Be prepared and store during less busy periods



# Ice Building Tank

IBT is a system, which stores energy in the form of ICE. Our Ice Building Tank is applicable in Dairy Industry for quick process in short time with certain limit of power load.

## Advantage

- ◆ Requires Less connected power load
- ◆ The ice water intensively cools the product without any risk
- ◆ Power supply is not required once Ice Formation is Completed
- ◆ No requirement of Cooling Tower and Water Supply (For Air Cooled type)
- ◆ Wide capacity with Storage tank upto 1,00,000 Ltr. / 33,000 KG ice formation per day
- ◆ Cooling energy storage capacity upto 900 TR/Day

## Features

- ◆ No Need of Civil & Fabrication Work At Customer Site
- ◆ Easy To Lift & Shift
- ◆ 40% Energy Efficient
- ◆ Better Insulation



# Ice Cream Hardener

We offer a superior hardening system backed by advanced and innovative engineering. Our hardener is static type and tunnel type and it is used to hard ice cream, ice candy and frozen food in certain time.

**Static type:** The static type hardener is design for easy to use and maintain.

**Application:** Ice Cream / Ice Candy & Frozen Food Hardening

**Temperature:** -22 °C to -26 °C

**Capacity:** 200 and 320 Ltr

**Pull Down Time :** 6 to 8 Hrs approx.

**Tunnel type:** The tunnel hardener is design to optimized airflow and minimize energy consumption.

**Application:** Ice Cream / Ice Candy & Frozen Food Hardening

**Temperature:** Heavy Duty: -26 °C to -30 °C

**Cascade Type:** -26 °C to -40 °C

**Capacity:** 450 and 2100 Ltr

**Hardening Time:**

- ◆ Ice Candy-15 minutes • Ice cream Cup & Cone-45 minutes • 1/2 Ltr Family Pack-1.3 hrs • 1 Ltr-2.0 hrs • 4 Ltr Bulk-4 hrs • 20 Ltr Nali-6 hrs



# Ice Candy Production Machine

We manufacture wide range of ice candy production machine using high quality material & advanced technology which is to be used for the production of Ice Candies. Our machine is designed for use where space is limited but high production capacities are required, all the variants are developed and built for easy to use. The production capacities changes depending on the moulds, but quality and flexibility remains the same.

**Application:** To produce Ice Candy, Roll cut Ice cream

**Mould Capacity:** 4 to 40

**Candy Capacity:** 192 to 1920 per hour

**Temperature:** -26 °C to -30 °C

## Features

- ◆ Solid waste free clean brine due to brine filter
- ◆ Beltless agitator
- ◆ Well designed for brine circulation to maintain uniform temperature

## Defrosting cum Choco Coating Tank

We offer single and double mould tank, our defrosting tank is used to defrost the candies from the mould and choco coating tank is used to make uniform layer of choco on each candy.



# Heat Pump Food Dehydrator

A device that transfer heat from a colder area (ambient temperature) to a hotter area (drying chamber) by using mechanical energy (refrigeration technology)

## Benefits :

- ◆ Premium Drying Quality Clean
- ◆ Hygienic & Easy to Operate
- ◆ Exact Control of Temperature and Humidity
- ◆ PLC Base Controlling
- ◆ Retain High Nutrition Intact
- ◆ Highest Efficiency in Drying
- ◆ Occupies Minimum Space

## Features:

- ◆ Energy saving & Environmental protection Saving operating cost, No Heat Loss (insulation chamber and recirculation of hot air), low noise
- ◆ Exact control of temperature and humidity According to different material require different drying temperature, Heat pump can control drying Temperature between 30 to 75 °C and relative humidity below 25 %

**Capacity:** 20 to 1400 KG/batch

## Features:

Drying of

- ◆ Fruits
- ◆ Vegetables
- ◆ Agriculture Product
- ◆ Herbs
- ◆ Sea Food
- ◆ Food



# Container Coldroom

Snowland Cooling Systems LLC specializes in the manufacturing of customized chiller, freezer, and blast chiller/freezer units using repurposed 20ft and 40ft containers. These innovative solutions provide flexible, portable, and cost-effective refrigeration options for a variety of applications, including remote locations, temporary storage, and specialized industrial needs. Our container units are designed to deliver reliable, energy-efficient performance while maximizing space and durability. Tailored to meet specific client requirements, these units offer a sustainable approach to high-performance refrigeration, blending functionality with eco-friendly practices.



# Chilling Plant

Snowland is a leading refrigeration company dealing with various kind of industrial chillers for end to end solutions. We are committed to provide best solution to customers, which fulfill their needs. We have a wide range of air cooled & water cooled chillers. The range of our chillers is 2 TR to 200 TR. Snowland chillers are ideal for various industries like pharmaceuticals, plastics, foods & beverages, dairy & milk processing, chemical industries etc.

## Features

- ◆ Scroll Compressor Chillers - Air Cooled & Water Cooled
- ◆ Screw Compressor Chillers - Air Cooled & Water Cooled
- ◆ Glycol Chillers - Air Cooled & Water Cooled
- ◆ Air Cooled Chiller – Online & Offline
- ◆ Air Chiller

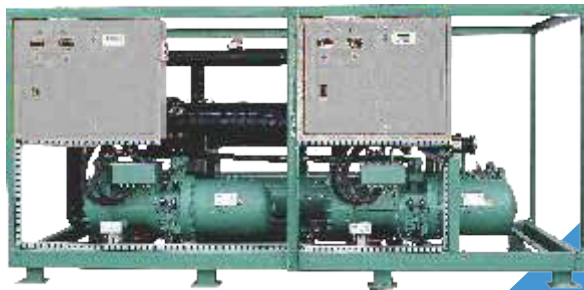

## Features

- ◆ Availability of Customized Solution
- ◆ Eco-friendly Refrigerant
- ◆ Wide Range of Water/Glycol Temp. (+15°C to -25°C)
- ◆ Closed Circuit operation
- ◆ Modular Design
- ◆ Easy operation & less Maintenance
- ◆ Compact in size



# Ripening Chamber

Snowland Refrigeration Limited provides most advanced fruits ripening rooms for fruits like mango, banana and papaya. We provide forced draft cooling system for uniform ripening of fruits even in large capacity rooms. We use blended gas system for the purpose of ripening which is acceptable as per universal standard. With our system, client has unique advantage of controlling ripening cycle from four to fifteen days! We provide precise gas monitoring system for better storage life of the produce.



## Features

- ◆ Microprocessor controlled and compatible with computer
- ◆ Low Cost and light weight, constructed with PUF-panels
- ◆ Low investment and maintenance cost
- ◆ Easy to commission, Swing or Sliding door
- ◆ Ripening capacities from 5 tons to 25 tons for each chamber
- ◆ Moveable from one site to another and expandable
- ◆ Controlled levels of Ethylene, CO<sub>2</sub>, Temperature, humidity & time
- ◆ Energy efficient, uniform and quality ripening
- ◆ Ripening chambers are reliable with energyefficient refrigeration units

# Loading Bay Equipment

Snowland Cooling Systems LLC specializes in supplying and installing top-quality loading bay equipment, including dock levelers, dock shelters, and sectional overhead doors. Our solutions are designed to optimize the efficiency and safety of loading and unloading operations in warehouses, cold storage facilities, and industrial settings. With a focus on durability and reliability, our loading bay equipment enhances operational workflows, ensures thermal protection, and improves energy efficiency. Whether upgrading existing facilities or outfitting new ones, Snowland Cooling Systems LLC delivers seamless installation and superior performance to meet the specific needs of your loading bay operations.



# Floor Finishes



Contemporary Safety Floor finish for wet application for premium kitchens



Kota Stone/Tiled Floor finish for wet & rough application for all types of kitchens and processing halls.

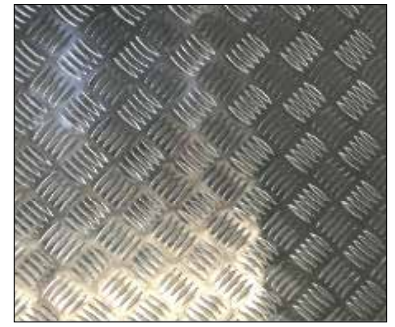

Aluminium Chequered 1.2 to 3.0 mm for Pharma, Ice Cream and any water free applications



Galvanized Sheet. 0.5/0.6/0.8/1.0/1.2/1.5 mm for dry applications



S.S. Dimple plates 0.8 to 2.0 mm for all dry type special applications

## Polyurea Coating Flooring

Snowland Cooling Systems LLC provides specialized polyurea coating flooring solutions for commercial and industrial cold rooms, cold storage, freezer rooms, and blast chillers/freezers. Our polyurea coatings are designed to offer exceptional durability, waterproofing, and resistance to chemicals and abrasion, making them ideal for demanding, temperature-controlled environments. This advanced flooring solution ensures superior thermal insulation, easy maintenance, and enhanced safety with anti-slip properties. Perfect for food processing facilities and other industrial applications, Snowland Cooling Systems LLC delivers polyurea-coated flooring that combines longevity, performance, and protection against the harshest conditions.



# Hygienic, Wall Protection and Ceiling Suspensions Accessories

At Snowland Cooling Systems LLC, we understand that maintaining hygiene and durability in cold storage environments is crucial. That's why we offer a range of accessories designed to protect your cold room's structural integrity and ensure the highest standards of cleanliness.

Our Accessory Range Includes:

- Covings
- Backing Profiles
- Plinths
- Bumper
- Suspensions



# Commercial & Industrial Refrigeration Consultancy Services

We are more than just a manufacturer; we are your trusted partner in ensuring optimal refrigeration performance across your business. With years of expertise in the industry, we offer comprehensive consultancy services tailored to meet the unique needs of both commercial and industrial clients.

## Our Expertise

Our consultancy team brings deep technical knowledge and hands-on experience in designing, installing, and maintaining advanced refrigeration systems. We specialize in delivering solutions that enhance efficiency, reduce energy costs, and ensure compliance with industry standards.

## Services We Offer

**System Design & Engineering:** We work closely with you to design custom refrigeration systems that align with your operational requirements. Whether you're expanding an existing system or building from the ground up, our experts ensure that your refrigeration infrastructure is optimized for peak performance.

## Energy Efficiency Audits

Our team conducts detailed audits to assess the energy consumption of your refrigeration systems.

We identify areas for improvement, recommend upgrades, and implement strategies to reduce your carbon footprint and operating costs.

## Regulatory Compliance Consulting

Navigating the complexities of refrigeration regulations can be challenging. We provide guidance to ensure that your systems comply with local, national, and international standards, helping you avoid costly penalties and ensure operational safety.

## Troubleshooting & Performance Optimization

If your refrigeration system isn't performing as expected, our consultants are here to help. We diagnose issues, provide actionable recommendations, and oversee the implementation of improvements to restore your system's efficiency.

## Training & Support

Empower your team with the knowledge they need to operate and maintain your refrigeration systems effectively. We offer customized training programs and ongoing support to keep your operations running smoothly.



# After Sales Services



Snowland is committed to supporting our clients long after installation. Our comprehensive after-sales service is managed through advanced CRM software, ensuring efficient tracking and prompt responses to service requests. Backed by a dedicated service team, we provide reliable maintenance and support for all your industrial and commercial refrigeration needs.

**CRM-Managed Support:** Our CRM system streamlines service management, ensuring no detail is overlooked and that your service requests are handled swiftly.

**Dedicated Service Team:** Experienced professionals ready to assist with maintenance, troubleshooting, and system optimization, ensuring your refrigeration systems operate at peak efficiency.

**Proactive Maintenance:** We offer scheduled maintenance services to prevent issues before they arise, extending the lifespan of your equipment.



We offer a fully equipped cold room service vehicle, supported by a dedicated team available 24/7.



ColdTech-IoT is designed to read and exchange desired monitoring Data of Connected Devices and Systems over Communication Networks.

The connection to the ColdTech cloud (iot.coldtechgroup.com) is via GPRS network/Wi-Fi allows the user to always stay in contact with the Communicating Devices by receiving real-time data and having immediate notifications directly on the Smartphone.

It makes user possible to have Real time status, manage alarms, print reports, modify operating parameters so able to monitor and whole system very easily.

- **Accessibility:** 24 x 7 Access over web portal and mobile app to view real-time status.
- **Dashboard:** List view and 24 Hrs. Graph gives easy summarized display of connected devices.
- **Notifications:** Alert notifications through SMS (In India) and Email.
- **Data Downloading:** Reports in .pdf or .csv format are available. User can create Scheduled Email Reports.
- **Historical data:** For analysis and audit purposes with given selection of time/date interval.
- **Analytics:** Possible with Graphs for selected parameter for given devices.
- **Data security:** The system will be protected with User ID and Password and hence only the authorized users will be able to access the system.

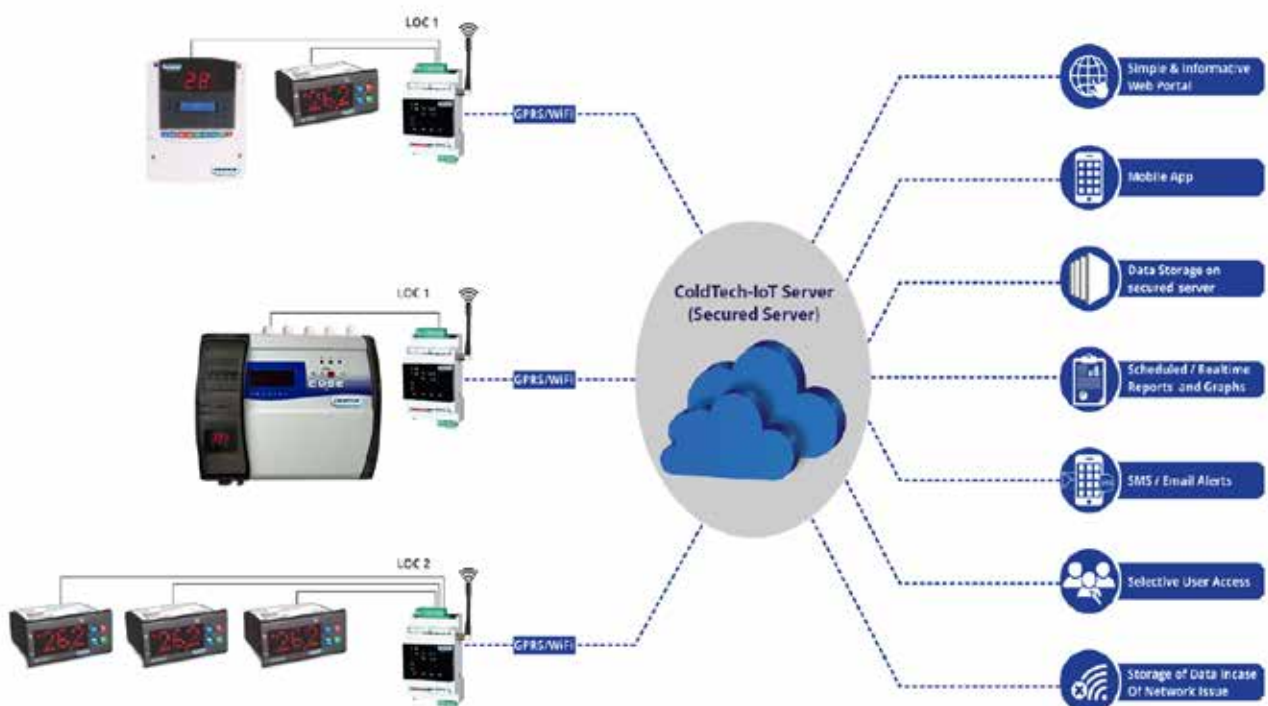

	RS-485 +
	RS-485 -

# Wall Drain System



Snowland Cooling Systems LLC offers specialized wall drain P-trap accessories designed specifically for hospitality cold rooms. These accessories are crucial for preventing the backflow of water, which helps maintain a hygienic environment by blocking bacteria and unpleasant odors from returning into the cold room.

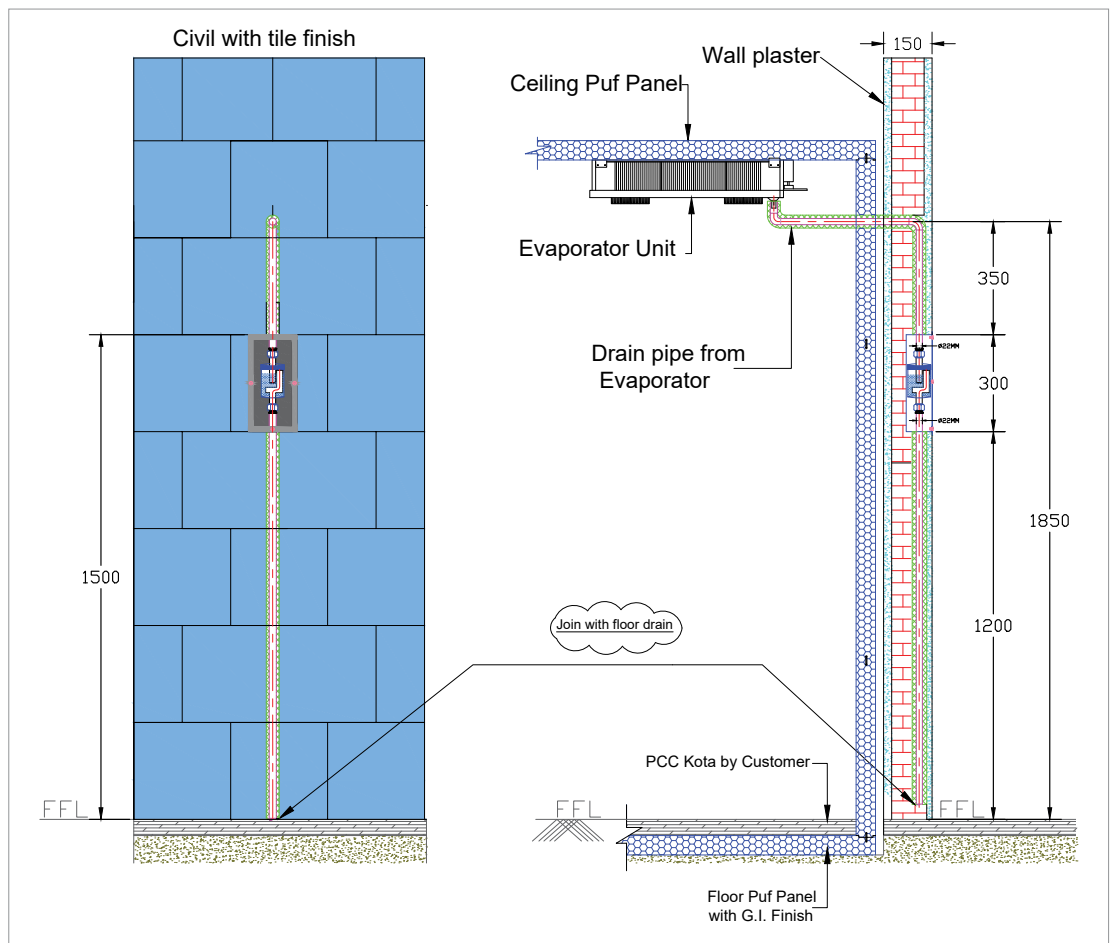
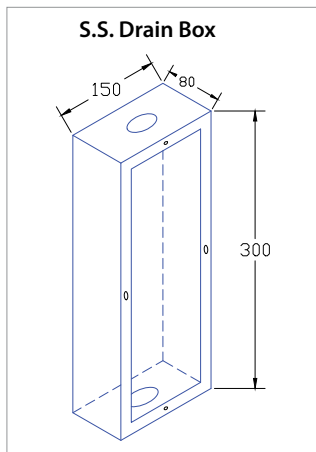
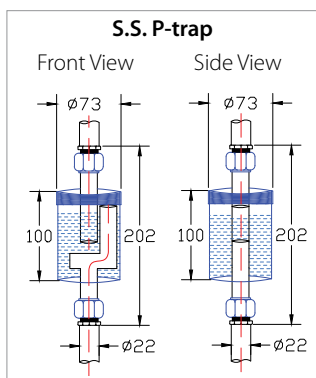

## Brands we work with



Reliability You Trust



# Refrigeration Energy Saver

Endo-Cube is a NSF certified revolutionary food temperature-mimicking sensor (TMS) designed to increase the lifespan of the compressor whilst saving on energy bills through its life. With Endo-Cube, the compressor cycles less by up to 80%, thereby extending the life of the compressor. Studies also reveal that refrigeration systems use up to 22% less energy with its use.

## How the Endo-Cube works

- Endo-Cube measures the product temperature instead of the air temperature around the product.
- The food simulant mimics food temperature at around 10mm below the surface.
- It senses food simulant and maintain stored products at the right temperature.
- It works as a refrigeration cycle controller by controlling Thermostat operation
- Upto 80% reduction in On & Off cycles of the refrigeration, although cycles are little longer.

## Top 6 reasons WHY you need Endo-Cube

- Reduce your refrigeration energy costs by up to 22%
- Increase the lifespan of your refrigeration equipment
- Improves quality and fresher of your produce
- Reduce servicing/repair costs to your equipment
- No ongoing maintenance needed
- Hassle free installation with no downtime



# Scope of Project Execution

<u>Pre-Sales</u>	<u>Post Sales</u>	<u>Execution</u>	<u>Beyond</u>
Heat load	Site visit	Site Checking	Post care
Selection	Drawing approval	Erection	AMC
Offer	Production	Testing	CMC
Order	Transportation	Commissioning	Spares
	Site coordination	Handing over	

# Demographic Presence

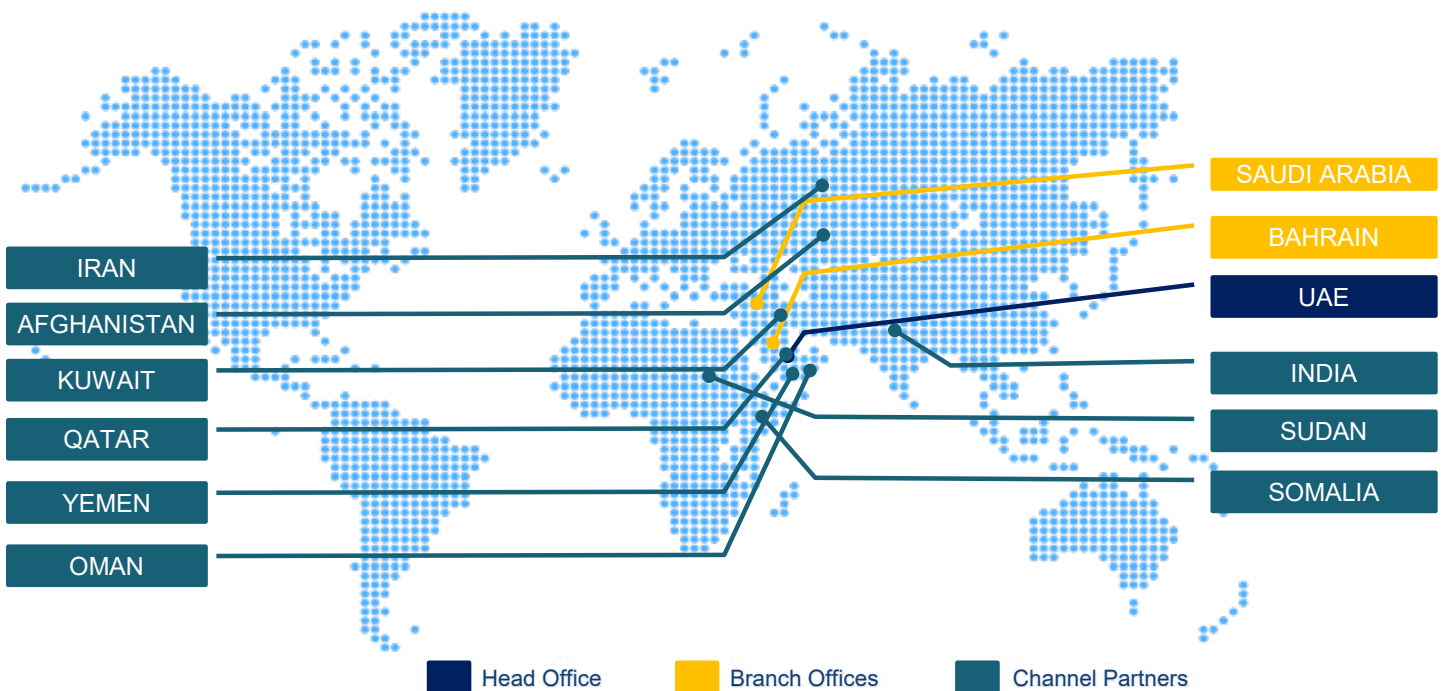

# Our Valued Clients





**Snowland Cooling Systems L.L.C.**

PO BOX :90334, Dubai, UAE

Email: [info@snowlandgulf.com](mailto:info@snowlandgulf.com)

Web: [www.snowlandgulf.com](http://www.snowlandgulf.com)

We reserve the right to change the design or measurements  
This catalogue is not contractually binding  
Specifications are subject to change without prior notice due  
to continuous product development